

ST 010 106 1705



- Ausladung 200 mm
- starrer Auslauf
- rechteckiges Strahlbild mit 40 Einzelstrahlen
- Armaturenhöhe 343 mm
- Höhe bis Luftsprudler 329 mm
- Bohrungsdurchmesser Seitenventil 32 mm
- Bohrungsdurchmesser Auslauf 35 mm
- 2x Druckschlauch M 10 x 1 eingeschraubt, dichtheitsgeprüft
- Durchfluss max. 4 l/min
- Griff Ø 60 mm
- bleifrei
- Dieses Produkt leistet einen Beitrag zur Erfüllung der Vorgaben von nachhaltigen Gebäudezertifizierungen, z.B. LEED®, BREEAM®, DGNB

	Chrom	ST 010 106 1705-00
	Platin gebürstet	ST 010 106 1705-06
	Dark Platinum gebürstet	ST 010 106 1705-99

**Einzelkomponenten dieses Sets**

Für dieses Set benötigen Sie folgende Komponenten



1x 13 717 705-00



1x 20 000 740-00







1x 20 000 741-00



ST 010 106 1705



- Ausladung 200 mm
- starrer Auslauf
- rechteckiges Strahlbild mit 40 Einzelstrahlen
- Armaturenhöhe 343 mm
- Höhe bis Luftsprudler 329 mm
- Bohrungsdurchmesser 35 mm
- Durchfluss max. 4 l/min
- Anschluss 1/2"
- 2x Druckschlauch M 10 x 1 eingeschraubt, dichtheitsgeprüft
- bleifrei
- Dieses Produkt leistet einen Beitrag zur Erfüllung der Vorgaben von nachhaltigen Gebäudezertifizierungen, z.B. LEED®, BREEAM®, DGNB

	Chrom	13 717 705-00
	Platin gebürstet	13 717 705-06
	Dark Chrome	13 717 705-19
	Champagne gebürstet (22kt Gold)	13 717 705-46
	Champagne (22kt Gold)	13 717 705-47
	Dark Platinum gebürstet	13 717 705-99

ST 010 106 1705

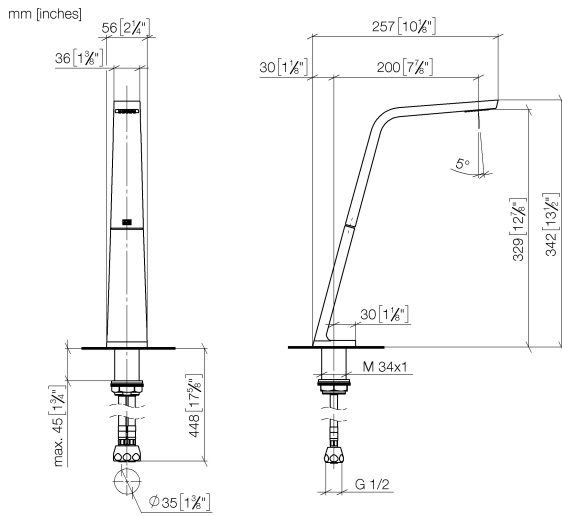

**Durchflussdiagramm**

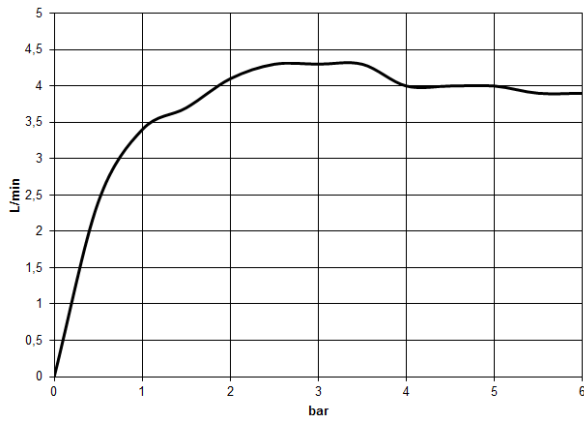

**Zertifikate**

GDV\_0400279.      LGA\_28686.      IAPMO\_N-4976.      IAPMO\_8834 (1).      IAPMO\_4976 (6).

WRAS\_1512011.      IAPMO\_6397.

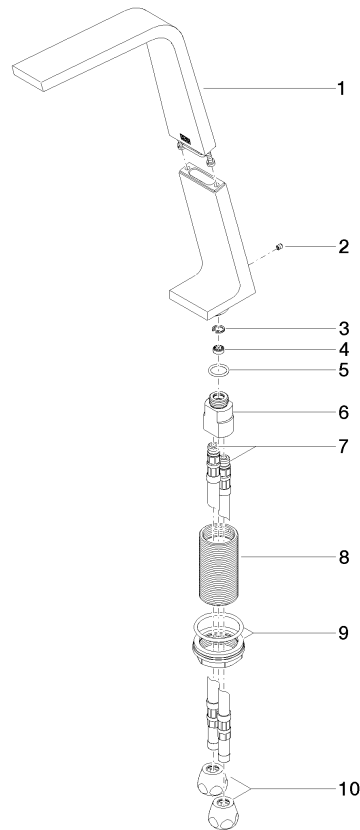

**Ersatzteilstückliste**







Nr.	Artikelnummer	Benennung	Verbaumenge	Lieferzeit
1	90 11 70 003 00-00	Auslauf	1	10
2	09 31 11 044 90	Stift	1	2
3	09 16 01 016 90	Ring	1	2
4	09 23 01 034 90	Durchflussbegrenzer	1	2
5	09 14 10 130 90	Dichtung	1	2
6	09 11 10 055 10 90	Anschluss	1	2
7	04 30 04 016 00 90	Schlauch	2	60
8	09 30 01 208 90	Anschluss	1	2
9	04 23 10 044 06 90	Befestigungssatz	1	2
10	90 23 30 040 00-00	Verschraubung	2	10

ST 010 106 1705

- Bohrungsdurchmesser 32 mm
- Griff Ø 60 mm
- ohne Rosette
- mit Kaltkennzeichnung



Passt zu: CL.1, CYO

	Chrom	20 000 740-00
	Platin gebürstet	20 000 740-06
	Platin	20 000 740-08
	Dark Chrome	20 000 740-19
	Messing gebürstet (23kt Gold)	20 000 740-28
	Schwarz matt	20 000 740-33
	Champagne gebürstet (22kt Gold)	20 000 740-46
	Champagne (22kt Gold)	20 000 740-47
	Dark Platinum gebürstet	20 000 740-99



ST 010 106 1705

mm [inches]

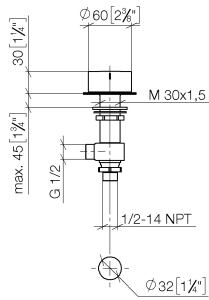

**Durchflussdiagramm**

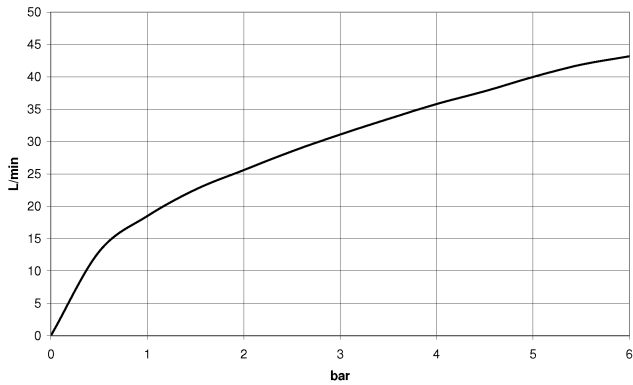

**Zertifikate**

IAPMO\_4976 (5). WRAS\_2103001. LGA\_28688.



ST 010 106 1705

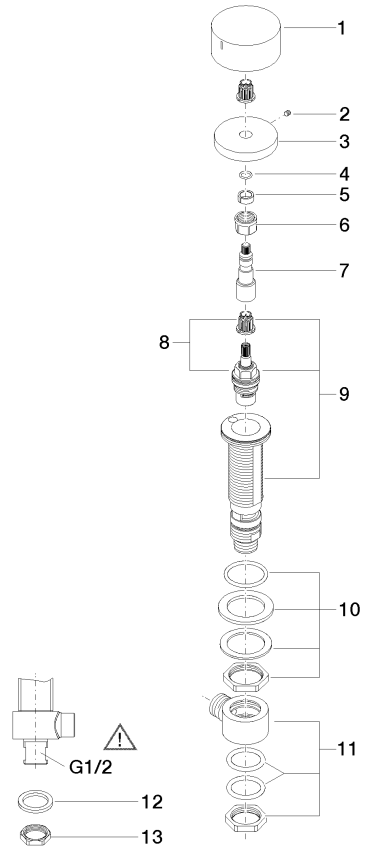

**Ersatzteilstückliste**









Nr.	Artikelnummer	Benennung	Verbaumenge	Lieferzeit
1	09 20 74 005-00	Griff ( cold )	1	10
2	90 31 11 007 00 90	Stift	1	2
3	09 27 74 003-00	Rosette	1	10
4	90 14 10 060 00 90	Dichtung	1	2
5	90 14 15 020 03 90	Ring	1	2
6	90 23 30 023 00 90	Mutter	1	2
7	09 29 06 107-00	Spindel	1	10
8	90 90 03 133 00 90	Oberteil	1	2
9	04 17 11 058 33 90	Seitenteil	1	2
10	04 23 10 032 78 90	Befestigungssatz	1	2
11	04 17 11 023 10 90	Verteiler	1	2
12	09 30 11 059 90	Scheibe	1	2
13	09 23 10 012 90	Mutter	1	2

ST 010 106 1705

- Bohrungsdurchmesser 32 mm
- Griff Ø 60 mm
- ohne Rosette
- mit Warmkennzeichnung



Passt zu: CL.1, CYO

	Chrom	20 000 741-00
	Platin gebürstet	20 000 741-06
	Dark Chrome	20 000 741-19
	Messing gebürstet (23kt Gold)	20 000 741-28
	Schwarz matt	20 000 741-33
	Champagne gebürstet (22kt Gold)	20 000 741-46
	Champagne (22kt Gold)	20 000 741-47
	Dark Platinum gebürstet	20 000 741-99



ST 010 106 1705

mm [inches]

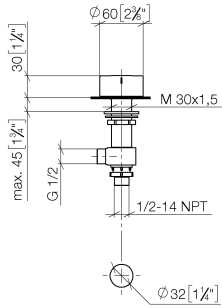

**Durchflussdiagramm**

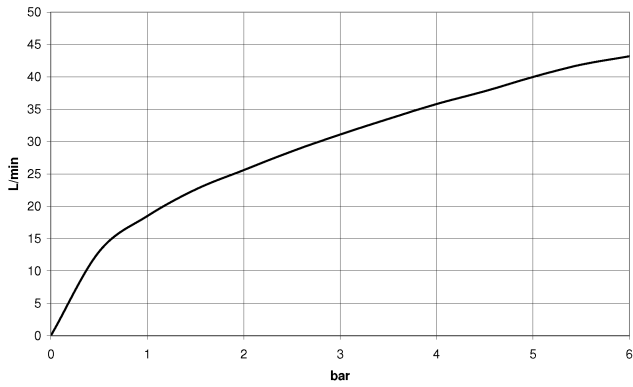

**Zertifikate**

IAPMO\_4976 (5). WRAS\_2103001. LGA\_28688.

ST 010 106 1705

Ersatzteile für die  
anderen  
Oberflächenvarianten  
finden Sie hier: Platin  
gebürstet

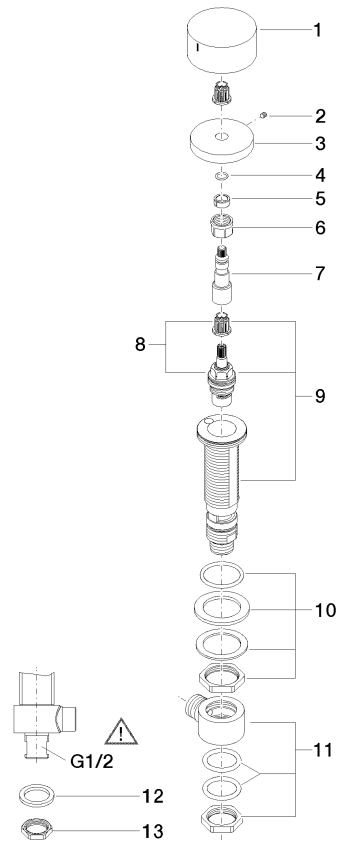

### Ersatzteilstückliste

Nr.	Artikelnummer	Benennung	Verbaumenge	Lieferzeit
1	09 20 74 006-00	Griff ( hot )	1	10
2	90 31 11 007 00 90	Stift	1	2
3	09 27 74 003-00	Rosette	1	10
4	90 14 10 060 00 90	Dichtung	1	2
5	90 14 15 020 03 90	Ring	1	2
6	90 23 30 023 00 90	Mutter	1	2
7	09 29 06 107-00	Spindel	1	10
8	90 90 03 132 00 90	Oberteil	1	2
9	04 17 11 058 32 90	Seitenteil	1	2
10	04 23 10 032 78 90	Befestigungssatz	1	2
11	04 17 11 023 10 90	Verteiler	1	2
12	09 30 11 059 90	Scheibe	1	2
13	09 23 10 012 90	Mutter	1	2